

64*CH Hybrid NDVR

for IP and Analog Camera

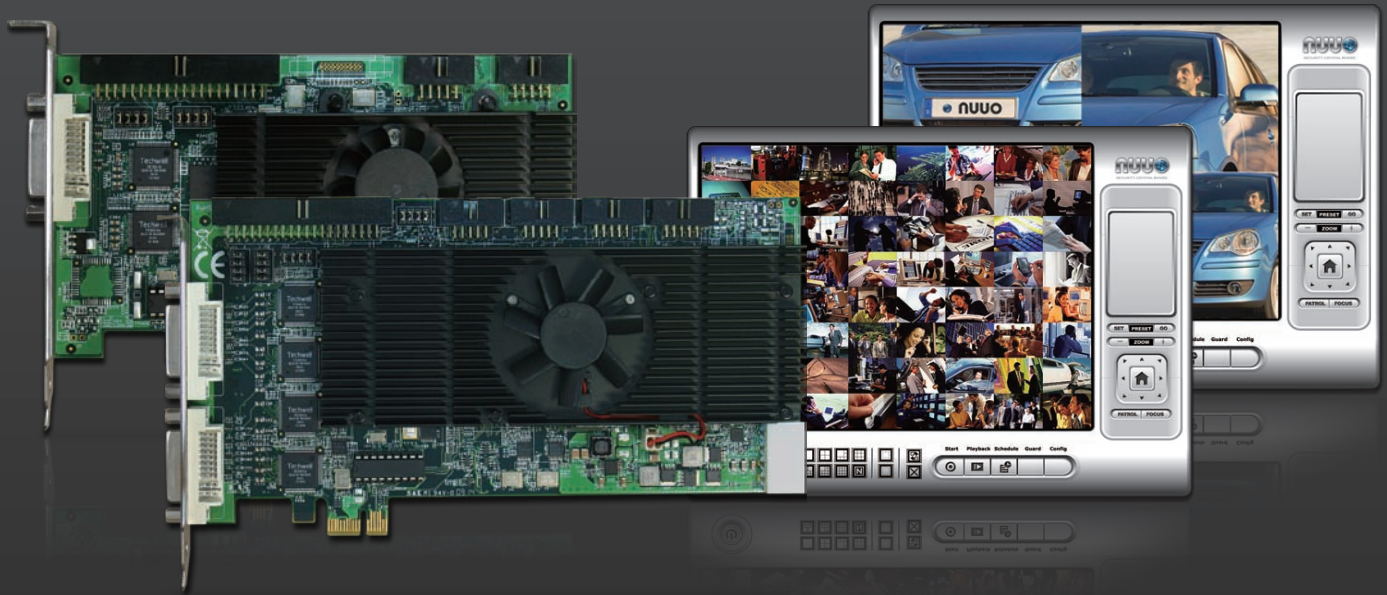

H.264 16CH D1 Real-time Recording

- Stackable Up to 32 Channels
- Supported by NUUO CMS
- Support Triple Monitors
- Up to 128 CH remote live view
- Support Instant Playback
- PCI-Express Interface
- Support POS
- Support 30 language
- Support Transcode
- Support iPhone

Support 37 camera brands and over 700 models



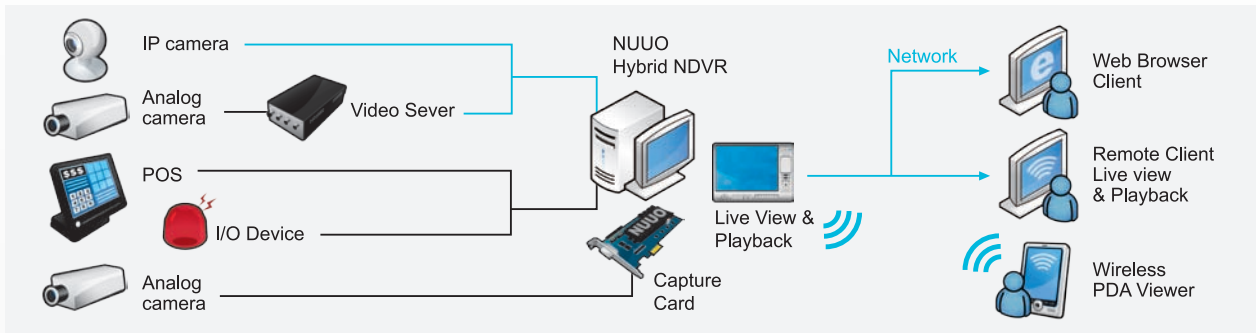

* The maximum number of camera connections depends on the server's hardware configuration and the total bit rate of the IP cameras. Please check NUUO Calculator on <http://support.nuuo.com/calculator/>

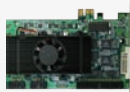
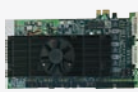

H.264 Hardware Compression Capture Card SCB 7000 Series

Product Name	SCB-7004	SCB-7008	SCB-7016
Video Inputs	4	8	16
Audio Inputs	4	8	16
Max. Cards Installation	4	4	2
Display Rate (NTSC/PAL)	120fps, 100fps	240fps, 200fps	480fps, 400fps
Recording Rate [D1] (NTSC/PAL)	120fps, 100fps @ D1 resolution	240fps, 200fps @ D1 resolution	480fps, 400fps @ D1 resolution
Video Resolution (NTSC)	176 x 120, 352 x 240, 704 x 480		
Video Resolution (PAL)	176 x 144, 352 x 288, 704 x 576		
Dimensions (W x H mm)	167 x 121	167 x 121	216 x 126
Product Image			

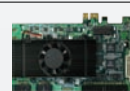
H.264 Hardware Comparison Capture Card SCB 6000 Series

Product Name	SCB-6004	SCB-6008	SCB-6016
Video Inputs	4	8	16
Audio Inputs	4	8	16
Max. Cards Installation	4	4	2
Display Rate (NTSC/PAL)	120fps, 100fps	240fps, 200fps	480fps, 400fps
Recording Rate [CIF] (NTSC/PAL)	120fps, 100fps	240fps, 200fps	480fps, 400fps
Video Resolution (NTSC)	176 x 120 ; 352 x 240; 704 x 480		
Video Resolution (PAL)	176 x 144 ; 352 x 288 ; 704 x 576		
Dimensions (W x H mm)	167 x 121	167 x 121	216 x 126
Product Image			
	<small>*Recording 30/25 fps @ D1 resolution</small>	<small>*Recording 60/50 fps @ D1 resolution</small>	<small>*Recording 120/100 fps @ D1 resolution</small>

MPEG4 Software Compression Capture Card SCB 3000 Series

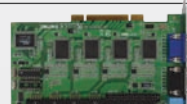
Product Name	SCB-3004	SCB-3008	SCB-3016
Video Inputs	4	8	16
Audio Inputs	4	4	4
Max. Cards Installation	2	2	2
Display Rate (NTSC/PAL)	120fps, 100fps		
Recording Rate [CIF] (NTSC/PAL)	120fps, 100fps		
Video Resolution (NTSC)	352 x 240, 640 x 480, 704 x 480		
Video Resolution (PAL)	352 x 288, 640 x 576, 704 x 576		
Dimensions (W x H mm)	200 x 120		
Product Image			

MPEG4 Software Compression Capture Card SCB 1000 Series

Product Name	SCB-1004	SCB-1008
Video Inputs	4	8
Audio Inputs	1	1
Max. Cards Installation	4	4
Display Rate (NTSC/PAL)	30fps, 25fps	
Recording Rate [CIF] (NTSC/PAL)	30fps, 25fps	
Video Resolution (NTSC)	352 x 240, 640 x 480, 704 x 480	
Video Resolution (PAL)	352 x 288, 640 x 576, 704 x 576	
Dimensions (W x H mm)	155 x 120	
Product Image	